

| Nº PEÇA | PEÇA | QTD | ESP | COMPR | LARG |
|---------|-----------------------|-----|-------|-------|-------|
| 1 | BASE | 1 | 0,025 | 0,910 | 0,540 |
| 2 | TAMPO | 1 | 0,025 | 0,910 | 0,540 |
| 3 | LATERAL DIREITA | 1 | 0,012 | 1,830 | 0,520 |
| 4 | LATERAL ESQUERDA | 1 | 0,012 | 1,830 | 0,520 |
| 5 | PRAT. MOVEL | 5 | 0,012 | 0,782 | 0,480 |
| 6 | TAMPO DO GAVETEIRO | 1 | 0,012 | 0,857 | 0,440 |
| 7 | BASE DO NICHOS | 1 | 0,012 | 0,857 | 0,498 |
| 8 | PRAT NICHOS (MENOR) | 4 | 0,012 | 0,423 | 0,496 |
| 9 | DIVISÓRIA SUPERIOR | 1 | 0,012 | 0,377 | 0,492 |
| 10 | PINAZZO | 3 | 0,012 | 0,857 | 0,060 |
| 11 | FRENTE GAVETA | 1 | 0,012 | 0,802 | 0,120 |
| 12 | CONTRA FUNDO | 1 | 0,012 | 0,757 | 0,095 |
| 13 | LATERAL GAVETA DIR | 1 | 0,012 | 0,387 | 0,100 |
| 14 | LATERAL GAVETA ESQ | 1 | 0,012 | 0,387 | 0,100 |
| 15 | DISTANCIADOR DIR | 2 | 0,025 | 1,205 | 0,060 |
| 16 | PUXADOR | 2 | 0,020 | 0,600 | 0,070 |
| 17 | COLMEIA MAIOR | 1 | 0,006 | 0,752 | 0,060 |
| 18 | COLMEIA MENOR | 4 | 0,006 | 0,365 | 0,060 |
| 19 | TRAVA CT FUNDO GAVETA | 1 | 0,015 | 0,375 | 0,060 |
| 20 | PORTA ESQ/DIR | 2 | 0,012 | 1,820 | 0,432 |
| 21 | FUNDO GAVETA | 1 | 0,003 | 0,770 | 0,386 |
| 22 | FUNDO TRASEIRO | 4 | 0,003 | 0,868 | 0,430 |
| 23 | DISTANCIADOR ESQ | 2 | 0,025 | 1,205 | 0,060 |

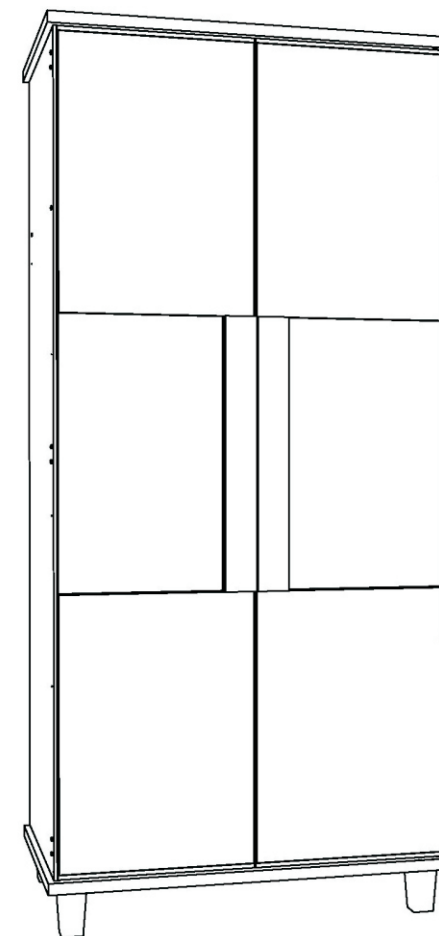

SAPATEIRA REQUINTE



ACESSÓRIOS

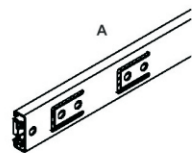

CORREDIÇA TELESCOPICA

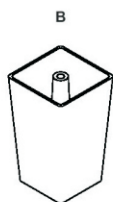

PÉS PLÁSTICOS 100 MM

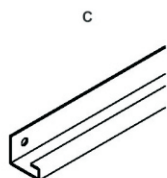

PERFIL METAL 794 MM



CHATO 3,5 x 12

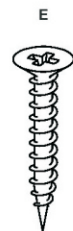

CHATO 3,5 x 25

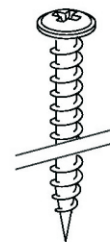

FLANGEADO 4,5 x 50

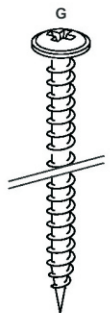

FLANGEADO 4,5 x 60

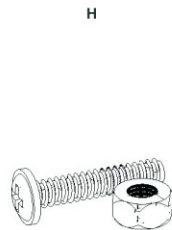

FLANGEADO M4 X 20 COM PORCA



CAVILHA 6 x 30

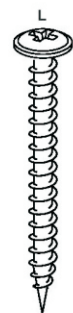

FLANGEAD 5,0 x 40



PINO MINI FX



TAMPA MINI FX

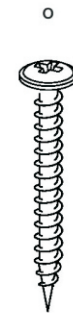

FLANGEADO 3,5 x 35

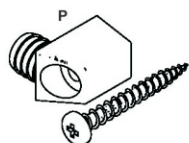

TRAPÉZIO +
PARAFUSO 3,5 X 22

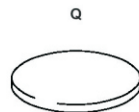

TAMPA FURO ADESIVO

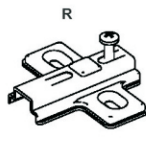

CALÇO

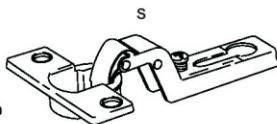

DOBRADIÇA 35 MM



PORCA PLÁSTICA



TRAVA P/ FUNDO



FLANGEADO 3,5 x 12

RUA MANOEL MEDEIROS CÂMARA, 25-56 | BAIRRO AEROPORTO
CEP. 15130-000 | MIRASSOL-SP | FONE (17) 3243-7010
E-MAIL: assistencia@rvmoveis.com.br

1° PASSO

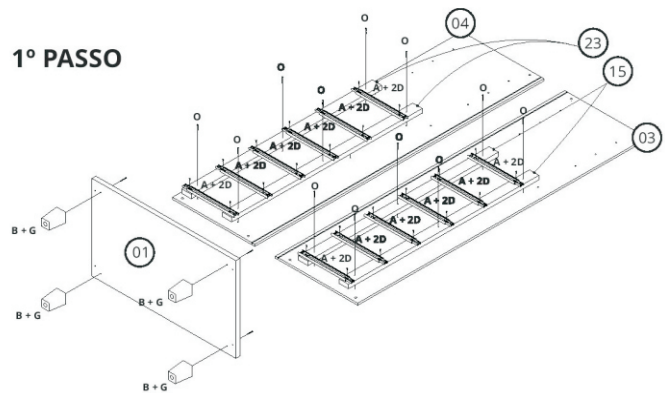

2° PASSO

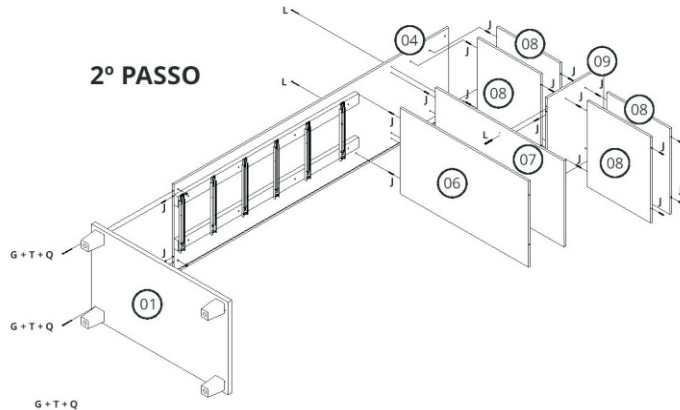

3° PASSO

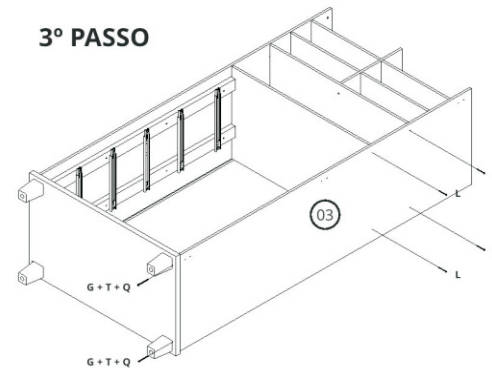

4° PASSO

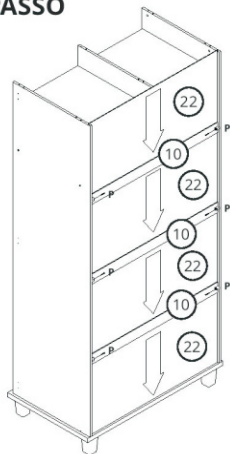

5° PASSO

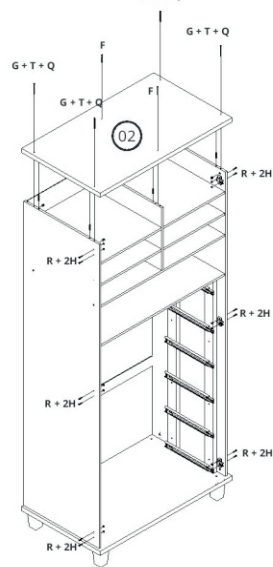

6° PASSO

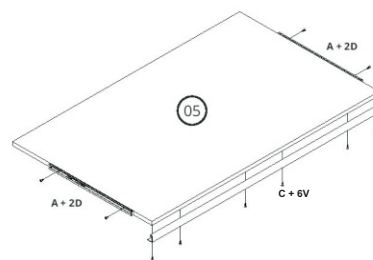

7° PASSO

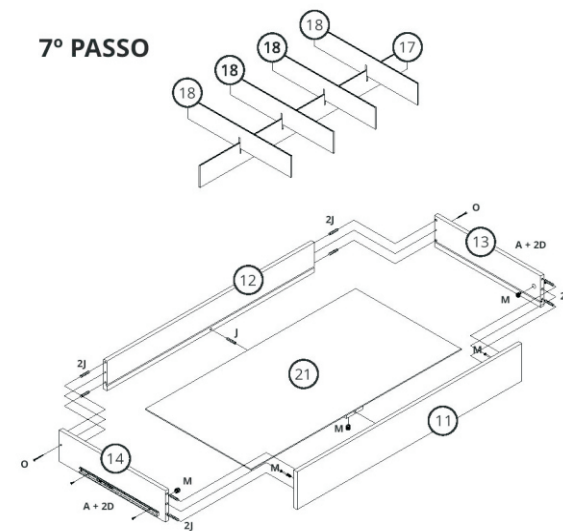

8° PASSO

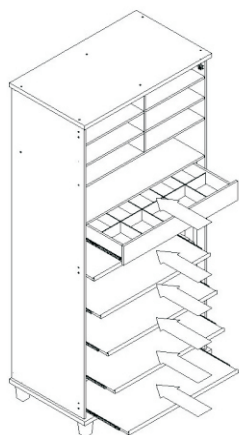

9° PASSO

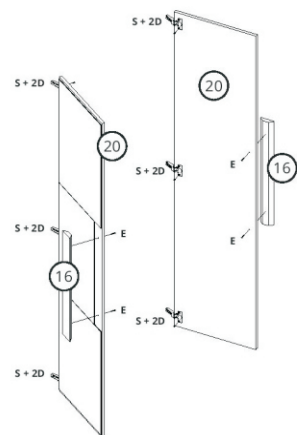

10° PASSO

